

Peak Emission Wavelength: 780nm

The 780nm NIR emitter is designed for applications requiring high output and precise optical mechanical axis alignment. Custom package solutions and sorting are available.

FEATURES

- > High Output Power
- > Narrow Beam Angle
- > High Reliability

APPLICATIONS

- > Bio Medical Applications
- > Optical Sensors
- > Optical Communications



Absolute Maximum Ratings (Ta=25°C)



ITEMS	SYMBOL	RATINGS	UNIT
Forward Current (DC)	IF	50	mA
Forward Current (Pulse)*1	IFP	0.5	A
Reverse Voltage	VR	5	V
Power Dissipation	PD	120	mW
Operating Temperature Range	Topr	-20 ~ +85	°C
Storage Temperature Range	Tstg	-30 ~ +100	°C
Lead Soldering Temperature*2	Tls	260	°C

*1: Tw=10μsec, T=10msec; *2: Time 5 Sec max, Position: Up to 3mm from the body.

Electrical & Optical Characteristics (Ta = 25°C)

ITEMS	SYMBOL	CONDITIONS	MIN	TYP	MAX	UNIT
Power Output	PO	IF=20mA	--	17	--	mW
Forward Voltage	VF	IF=20mA	--	1.6	--	V
Reverse Current	IR	VR=5V	--	--	100	μA
Peak Emission Wavelength	λp	IF=20mA	--	780	--	nm
Spectral Line Half Width	Δλ	IF=20mA	--	25	--	nm
Half Intensity Beam Angle	Θ	IF=20mA	--	±14	--	deg

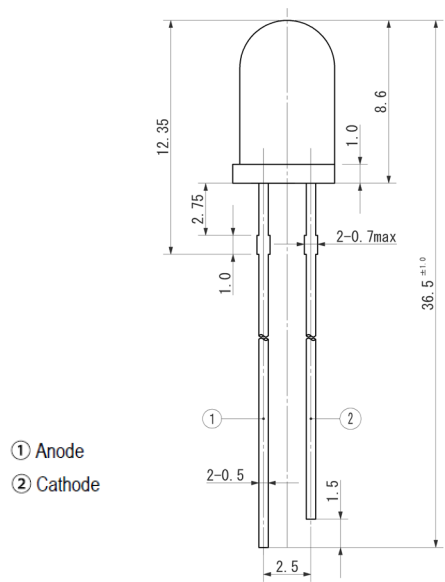

SPECTRAL RESPONSE

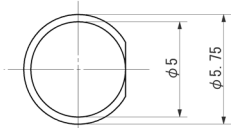
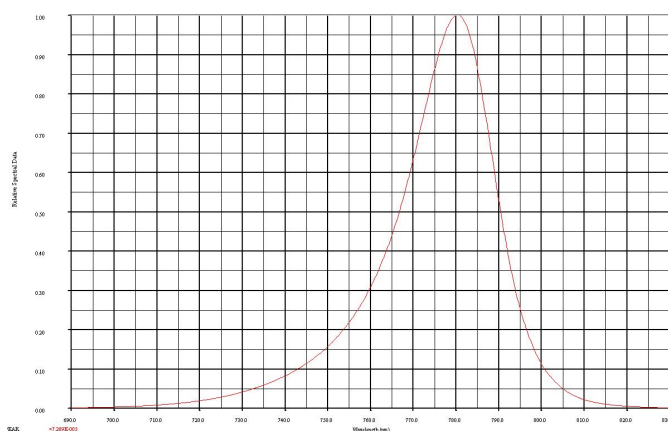

FORWARD I-V CHARACTERISTICS

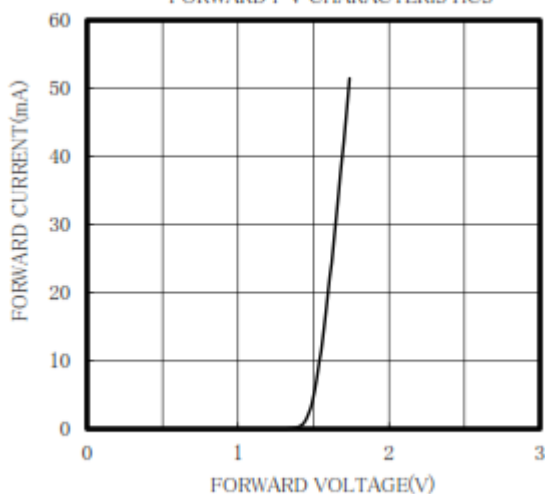

Unit: mm, Tolerance: ±0.2

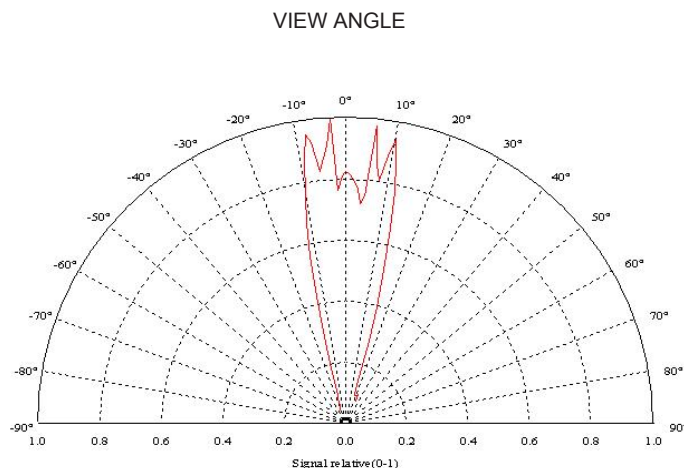
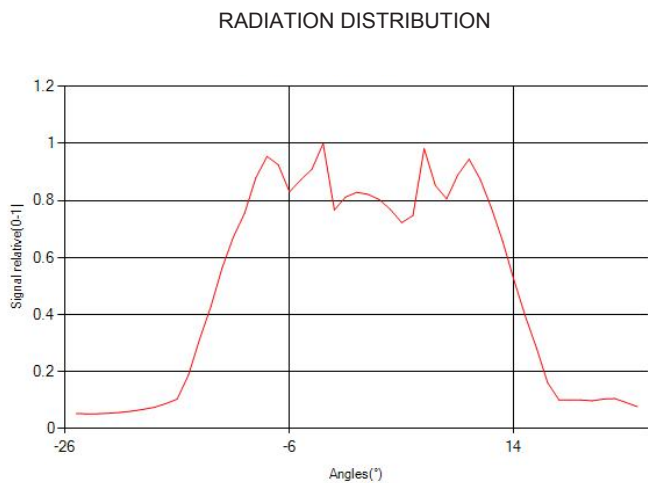
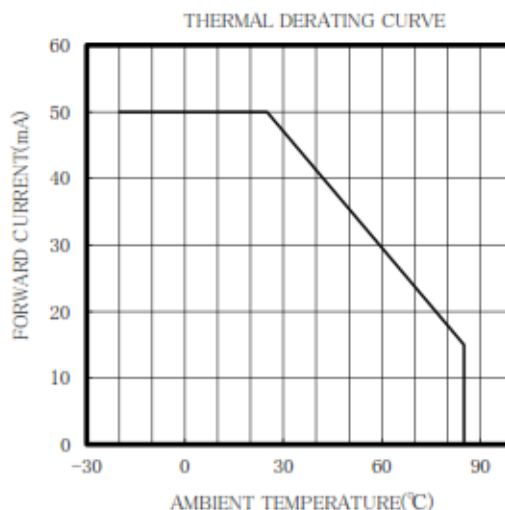
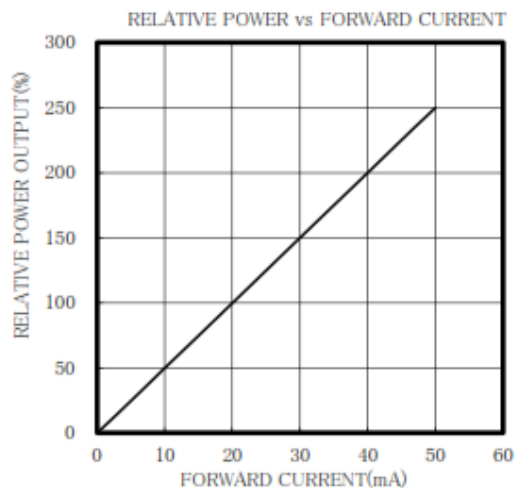

The information contained herein is subject to change without notice.

2024-11-07